

CARTE DES VINS ET CHAMPAGNES



: Label européen agriculture biologique

COTES DU RHONE A.O.C ROUGE

- Cotes du Rhône, Chateau Saint Roch, Famille Brunel 37.50 cl **16€00**
- Cotes du Rhône, Chateau Saint Roch, Famille Brunel 75 cl **24€00**
(70% grenache, 15% syrah, 15% cinsault)
- Crozes Hermitage, *Beaumont*, David Reynaud  37.50 cl **22€00**
- Crozes Hermitage, *Beaumont*, David Reynaud  75 cl **33€00**
(100% syrah)
- Vacqueyras, Brunel de la Gardine 75 cl **42€00**
(65% grenache, 25% mourvèdre, 10% syrah)
- Saint Joseph, Brunel de la Gardine 75 cl **46€00**
(100% syrah)
- Châteauneuf-du-Pape, Chateau La Gardine 50 cl **65€00**
- Châteauneuf-du-Pape, Chateau La Gardine 75 cl **81€00**
(60% grenache, 15% mourvèdre, 20% syrah, 5% muscardin)

SAVOIE A.O.C ROUGE

- Mondeuse, *Les Caillasses*, Domaine Bouvet 75 cl **34€00**
(100% mondeuse)

CHATILLON EN DIOIS A.O.C ROUGE

- *Loup du Loup*, Domaine Maupas  75 cl **31€00**
(50% gamay, 50% syrah)

BEAUJOLAIS A.O.C ROUGE

- Brouilly, Dominique Piron 37.50 cl **19€00**
- Brouilly, Dominique Piron 75 cl **28€00**
(100% gamay)



BORDEAUX A.O.C ROUGE

- Saint Emilion, *Cheval Noir* 37.50 cl **22€00**
- Saint Emilion, *Cheval Noir* 75 cl **36€00**
(70% merlot, 30% cabernet sauvignon)
- Saint-Estèphe, *Chateau Picard* 75 cl **48€00**
(90% cabernet sauvignon, 10% merlot)
- Pauillac, *Chapelle de Seize* 75 cl **65€00**
(60% cabernet sauvignon, 35% merlot)
- Margaux, *Chateau Palmer* 75 cl **595€00**
(50% cabernet sauvignon, 45% merlot, 5% petit verdot)

LANGUEDOC-ROUSSILLON A.O.C ROUGE

- La Clape, *La Cote*, Chateau La Négly 75 cl **25€00**
(30% carignan, 30% syrah, 30% grenache, 10% mourvèdre)
- Pic Saint Loup, *La Trévière*, Domaine des 3 Châteaux  75 cl **31€00**
(70% syrah, 30% grenache)
- La Clape, *La Falaise*, Chateau La Négly 75 cl **45€00**
(60% syrah, 15% grenache, 10% mourvèdre, 15% carignan)

VAL DE LOIRE A.O.C ROUGE

- St Nicolas De Bourgueil, Estelle Cognard, *Ma Cuvée DOR*  75 cl **38€00**
(100% cabernet franc)

BOURGOGNE A.O.C ROUGE

- Rully, Joseph Drouhin 37.50 cl **28€00**
- Rully, Joseph Drouhin 75 cl **55€00**
(100% pinot noir)
- Cote de Beaune Village, Joseph Drouhin 75 cl **65€00**
(100% pinot noir)

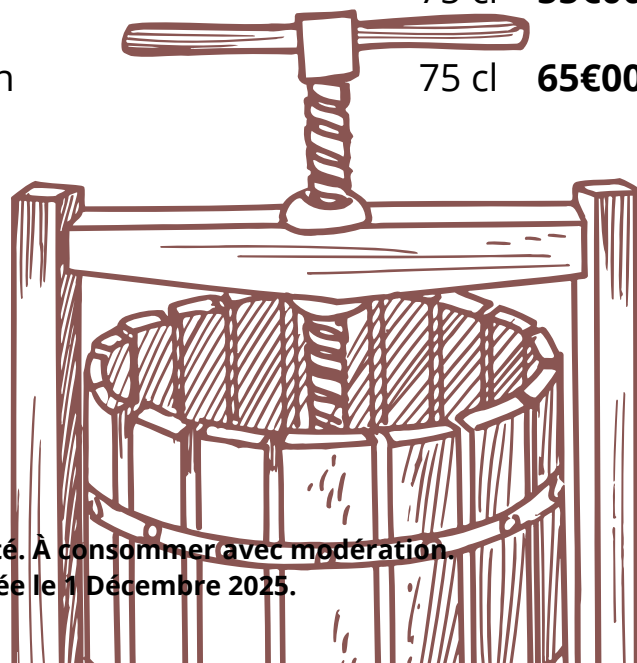

BOURGOGNE A.O.C BLANC

- Saint Véran, Domaine Duvert 
(100% chardonnay)
- Chablis, Joseph Drouhin-Vaudon
- Chablis, Joseph Drouhin-Vaudon
(100% chardonnay)
- Saint Romain, Joseph Drouhin
(100% chardonnay)



75 cl **38€00**

37.50 cl **28€00**

75 cl **52€00**

75 cl **68€00**

SAVOIE A.O.C BLANC

- Apremont, *Le Carozet*, Domaine Bouvet
- Apremont, *Le Carozet*, Domaine Bouvet
(100% jacquère)
- Chignin Bergeron, Domaine Bouvet
- Chignin Bergeron, Domaine Bouvet
(100% roussanne)
- Roussette, *Cuvée Henriette*, Domaine Bouvet
(100% altesse)

37.50 cl **16€00**

75 cl **24€00**

50 cl **29€00**

75 cl **38€00**

75 cl **32€00**

COTES DU RHONE A.O.C BLANC

- Crozes Hermitage, *Aux bêtises*, David Reynaud 
(80% marsanne, 20% roussanne)
- Condrieu, Brunel de la Gardine
(100% viognier)

75 cl **39€00**

75 cl **72€00**



ALSACE A.O.C BLANC

- Riesling, Leon Beyer
(100% riesling)
- Pinot Gris, *Leon Beyer*
(100% pinot gris)

75 cl **28€00**

75 cl **32€00**

CHATILLON EN DIOIS A.O.C BLANC

- Chatillon en Diois, Domaine de la Gouyarde  75 cl **28€00**
(100% aligoté)
- Vercors, Domaine Maupas  75 cl **31€00**
(100% chardonnay)

COTES DE GASCOGNE I.G.P BLANC

- *Premières Grives*, Domaine du Tariquet 75 cl **24€00**
(100% gros manseng)

VAL DE LOIRE A.O.C BLANC

- Sancerre, Domaine Henri Bourgeois, *Grande Réserve*  75 cl **42€00**
(100% sauvignon blanc)

LANGUEDOC-ROUSSILLON A.O.C BLANC

- La Clape, Chateau La Négly, *La Brise Marine* 75 cl **24€00**
(60% roussanne, 40% bourboulenc)
- Viognier Pays d'Oc, *Famille Fabre*, Domaine de Luc  75 cl **26€00**
(100% viognier)
- Pays d'Oc, Domaine La Négly, *La Falaise* 75 cl **42€00**
(chardonnay, grenache gris, sauvignon gris, petit manseng)







LANGUEDOC-ROUSSILLON A.O.C ROSE

- *L'écume*, Chateau La Négly 50 cl **16€00**
- *L'écume*, Chateau La Négly 75 cl **22€00**
(grenache, syrah, mourvèdre)
- Chateau Puech-Haut, *Argali* 75 cl **32€00**
(60% grenache, 40% cinsault)

COTES DE PROVENCE A.O.C ROSE

- *Diane*, Chateau pas du Cerf  50 cl **19€00**
(60% grenache, 10% mourvèdre, 10% cinsault, 20% tibouren)
- *Diane*, Chateau pas du Cerf  75 cl **29€00**
(60% grenache, 10% mourvèdre, 10% cinsault, 20% tibouren)
- *Lampe de Méduse*, Chateau Roseline  75 cl **36€00**
(50% grenache, 20% cinsault, 20% mourvèdre, 10% tibouren)

CORSE I.G.P ROSE

- San Pieru, *Ile de Beauté* 75 cl **26€00**
(grenache, sciacarellu)

CHATILLON EN DIOIS A.O.C ROSE

- Domaine de Maupas, *Zoé*  75 cl **25€00**
(gamay, pinot noir)

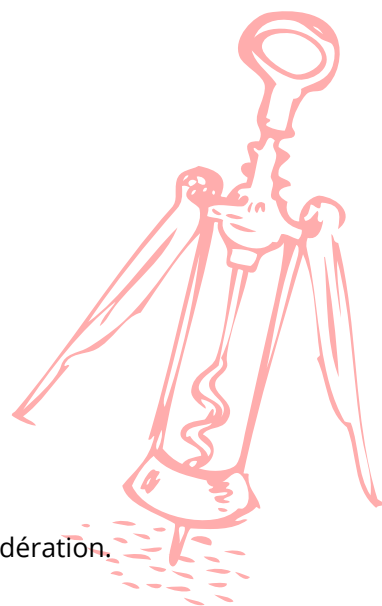

CHAMPAGNES

- Champagne Theophile Brut 75 cl **68€00**
- Champagne Louis Roederer Collection 37.50 cl **50€00**
- Champagne Louis Roederer Collection 75 cl **98€00**
- Champagne Cristal Roederer 75 cl **230€00**

PETILLANTS REGIONAUX

- Clairette de Die, *Jaillance*, Impériale 75 cl **25€00**
- Crémant de Die, *Jaillance*, Grande Réserve 75 cl **30€00**

